

1 & 2 pole protection

RoHS compliant

UL 1500 Ignition Proof

0.1 to 30 Amp capacity



Series 24

Raising the Bar

MP—Count on it



Mechanical Products Company

The Series 24 Overview

Multi-Functional to fit your design needs

The switchable, trip-free, MP Series 24 circuit breaker may be specified to meet a wide variety of circuit protection and/or switching requirements in ratings of 0.1 – 30A. The snap-in mount Series 24 may be specified as a circuit protector and/or switch, as a one or two pole device with splash and actuator guard options.

The Series 24 is certified for CSA C22.2 No.100-04 Portable Generators.

Series 24 Offers:

- AC/DC ratings from 0.1 to 30 Amps
- UL 1500 Ignition protection
- 1 & 2 pole protection
- RoHS compliant
- Splash Guard / Actuator Guard
- Lighted or unlighted

MP's Series 24 offers trip-free protection. It operates as a latched mechanism, in which the switch function (Power On/Off) is independent of the trip function (Overload Protection). The latch mechanism is tripped by means of a cantilever-beam current sensing element. The contacts travel through an arc diverter chamber to reduce arc-quenching time. The overall mechanism is extremely simple in design for reliable operation.
US Patent Number 4937548

Series 24 Physical Configuration

See Actuator Options for full variety of markings and colors

Single Pole w/ Quick Connect terminals

Typical envelope dimensions
Inches (mm)

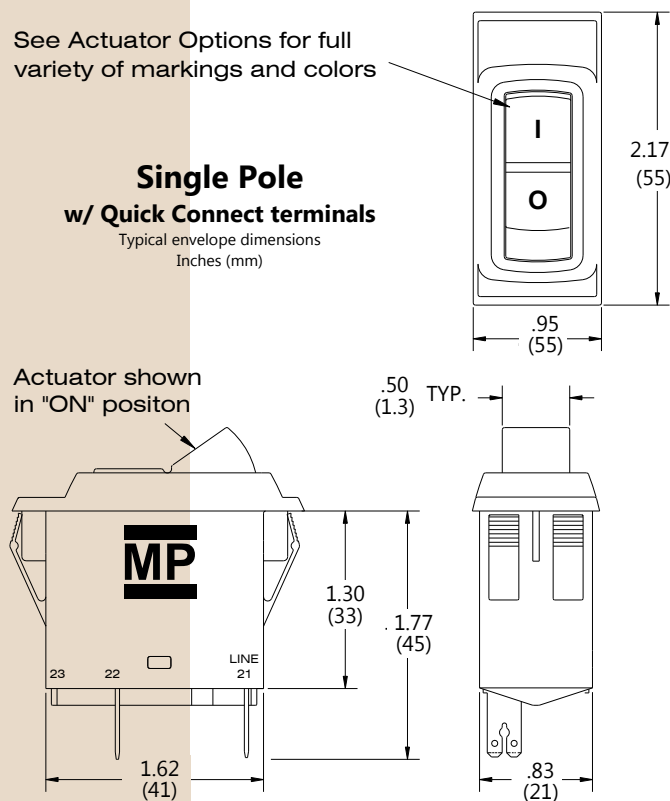

Two Pole w/ optional Screw terminals

Typical envelope dimensions
Inches (mm)

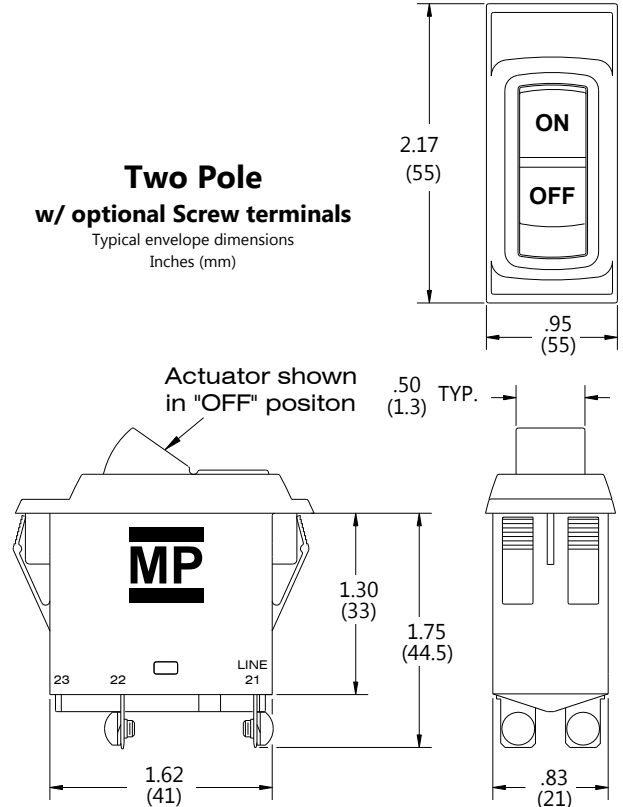

Mechanical Products Company

1112 N. Garfield St. Lombard, IL 60148 helpme@mechprod.com phone 630 | 953 | 4100 fax 630 | 953 | 4110 www.mechprod.com

Series 24 Panel Mount Openings (B)

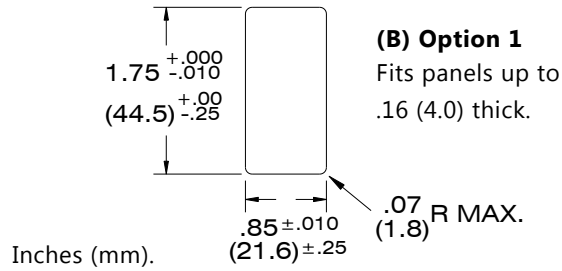
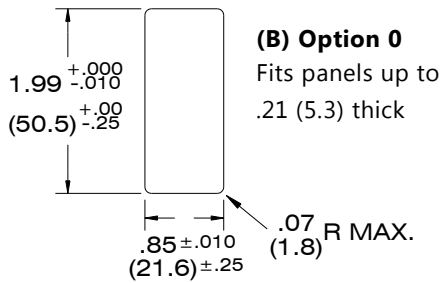

Series 24 Typical Trip Curves

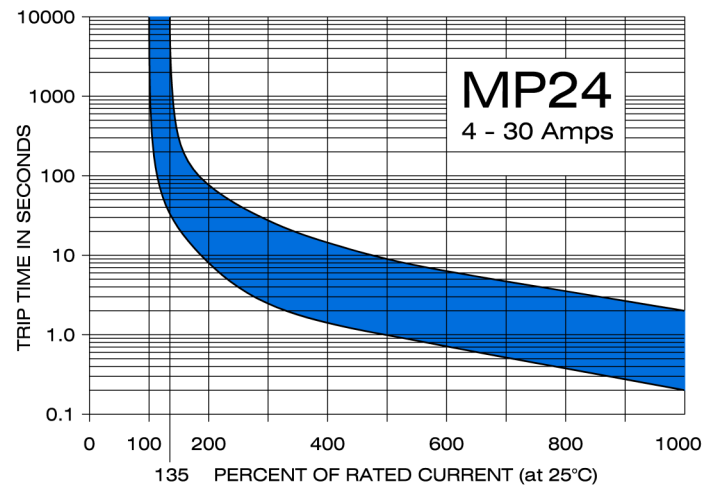
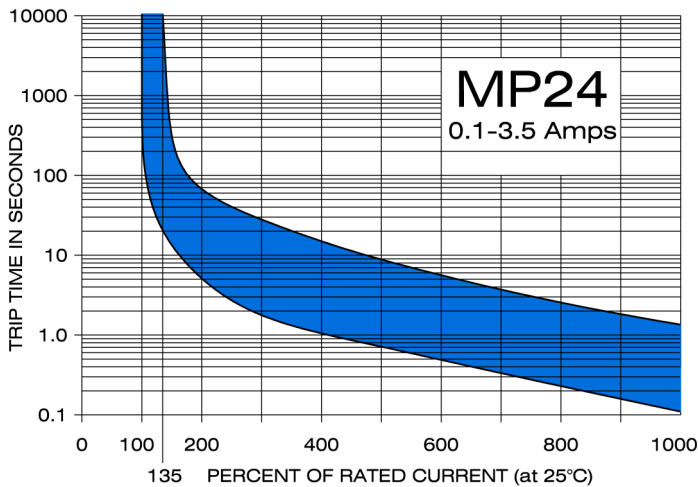

Series 24 Operating Characteristics

Minimum Ultimate Trip

100% of rated current at 25°C/77°F

Maximum Ultimate Trip

135% of rated current at 25°C/77°F

Voltage Drop

The Series 24 in ratings of 0.1-3.5 Amp has a maximum voltage drop of 9.0V at rated current.

The Series 24 in ratings of 4-20 Amp has a maximum voltage drop of .24V at rated current.

Overload Trip Time Data (seconds at 25°C)

Current Rating	200%	500%	1000%
0.1 - 3.5 Amps	8-60	0.7-5	0.3-2.0
4 - 30 Amps	8-80	1-4	0.2-1.5

Typical Ambient Temperature Correction Factor

Current Rating	-22°F	32	77	104	122	140
	-30°C	0	25	40	50	60
0.1 - 3.5 Amps	0.8	0.9	1.00	1.08	1.16	1.24
4 - 30 Amps	0.8	0.9	1.00	1.08	1.16	1.24



Mechanical Products Company

1112 N. Garfield St. Lombard, IL 60148 helpme@mechprod.com phone 630 | 953 | 4100 fax 630 | 953 | 4110 www.mechprod.com

Standard Amp Ratings

Series 24 supplementary circuit protectors can be specified for 0.1A, 0.2A, 0.3A, 0.4A, 0.5A, 0.6A, 0.8A, 1A, 1.25A, 1.5A, 2A, 2.5A, 3A, 3.5A, 4A, 4.5A, 5A, 6A, 7A, 8A, 10A, 12A, 14A, 15A, 16A, 18A, 20A, 25A, or 30A

Voltage Rating

Series 24 is rated at 250VAC/50VDC Max.

Rated Short Circuit Capacity I_{cn} (IEC60934)

0.1 – 2A, 10 x I_n
2.5 – 20A, 250A 2 pole, 150A 1 pole

Short Circuit Current Rating (UL1077)

UL 2 pole at 250VAC
0.1 – 0.4A, 200A (pending)
0.5 – 30A, 5,000A

UL 2 pole at 50VDC
0.1 – 0.4A, 1,000A (pending)
0.5 – 30A, 1,000A

Inrush Capacity

The Series 24 will not trip at 35X rated current for 1/2 cycle (0.008 sec.)

Typical Life

2 Pole
50,000 operations, $I_n \leq 16A$ (240VAC/50VDC)
30,000 operations, $I_n > 17A$ (240VAC)
10,000 operations, $I_n > 17A$ (50VDC)

1 Pole
30,000 operations, $I_n \leq 20A$ (240VAC)
30,000 operations, $I_n \leq 16A$ (50VDC)
30,000 operations, $I_n > 17A$ (28VDC)

Ambient Operating Temperature

-22 - +140°F (-30 - +60°C)

Dielectric Strength

The Series 24 has dielectric strength ratings of 2,000+VAC per IEC and 1,500+VAC per UL, CSA



Vibration

The Series 24 will withstand 8g (57-500Hz) as tested to IEC60068-2-6, Test Fc 10 frequency cycles/axis

Shock

The Series 24 will withstand 30g (11ms) as tested to IEC60068-2-27, Test Ea

Degree of Protection

The Series 24 is rated at IP40 for the operating area (IP54 with splash protection) and IP00 for the terminal area, per IEC 529/DIN 40050.

Corrosion

The Series 24 will withstand 96 Hrs at 5% salt spray as tested to IEC60068-2-11, Test Ka

Humidity

The Series 24 will withstand 240 Hrs at 95% RH as tested to IEC60068-2-3, Test Ca

Weight

The Series 24 two pole has a typical weight of 37g.

Regulatory Approvals

UL1077 recognized, File #E66224
CSA certified, File #LR27156 (MC# 164913)
VDE/IEC60934 License #40028901, 0.5-20 Amp
CCC CQC GB17701-1999, License Pending*

Illumination Voltage/Power Consumed

Nominal	
Lamp Voltage	Lamp current
5	114 mA @ 5 VDC
14	38 mA @ 12 VDC
28	23 mA @ 24 VDC
115	<1.5 mA @ 115 VAC
230	<1.5 mA @ 230 VAC

CSA Application Codes

1 Pole: 4-30A, 250VAC, 50VDC, TC3, OLO 250VAC, OL1 125VAC, (50VDC 4-20A OL1, 21-30A OLO)
SC:C1, 1kA 50VDC: SC:U3, 0.37kA 250VAC;
SC:C1, 5kA 250VAC

2 Pole: (1 ph., 2 pole break) 4-30A, 250VAC, 50VDC
TC3, OL1 250VAC, OL1 50VDC
SC:U3, 0.37kA 250VAC: SC:C1, 5kA, 250VAC
SC:C1, 1kA 50VDC

Industrial Equipment

Series 24 Quick Connect Terminals are suitable for "General Industrial" use.

Series 24 Poles (A)

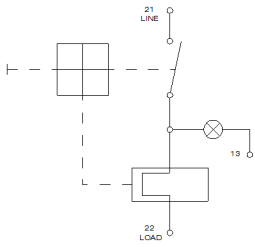

**(A) 1 pole,
thermally
protected**

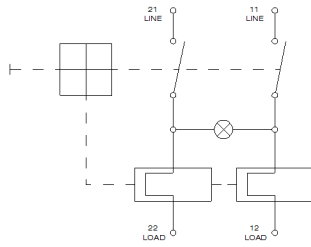

**(A) 2 poles,
thermally
protected**

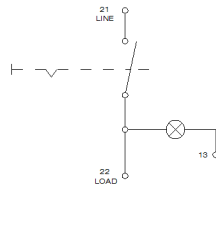

**(A) 1 pole,
unprotected,
switch only**

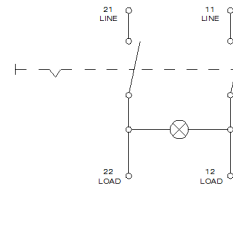

**(A) 2 poles,
unprotected,
switch only**

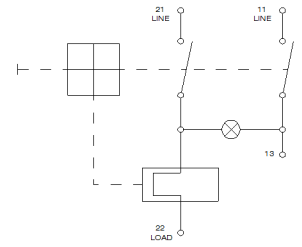

**(A) 2 poles,
one protected,
one unprotected**

Series 24 Actuator Options (C & G)

See back page for the complete list of options.



(C) Actuator Style 1
Standard Rocker



(C) Actuator Style 2
Rocker with
Splash Guard



(C) Actuator Style 3
Rocker with
Actuator Guard



(C) Actuator Style 4
Rocker with
Splash & Actuator Guard



Color 1



Color 2



Color 3



Color 4



Color 5

(G) Actuator Colors

Series 24 rocker actuators are available in a variety of colors, with green, red, amber and white translucent actuators for both lighted and unlighted applications, as well as unlighted black.



Mechanical Products Company

1112 N. Garfield St. Lombard, IL 60148 helpme@mechprod.com phone 630 | 953 | 4100 fax 630 | 953 | 4110 www.mechprod.com

Series 24 Part Numbering Guide

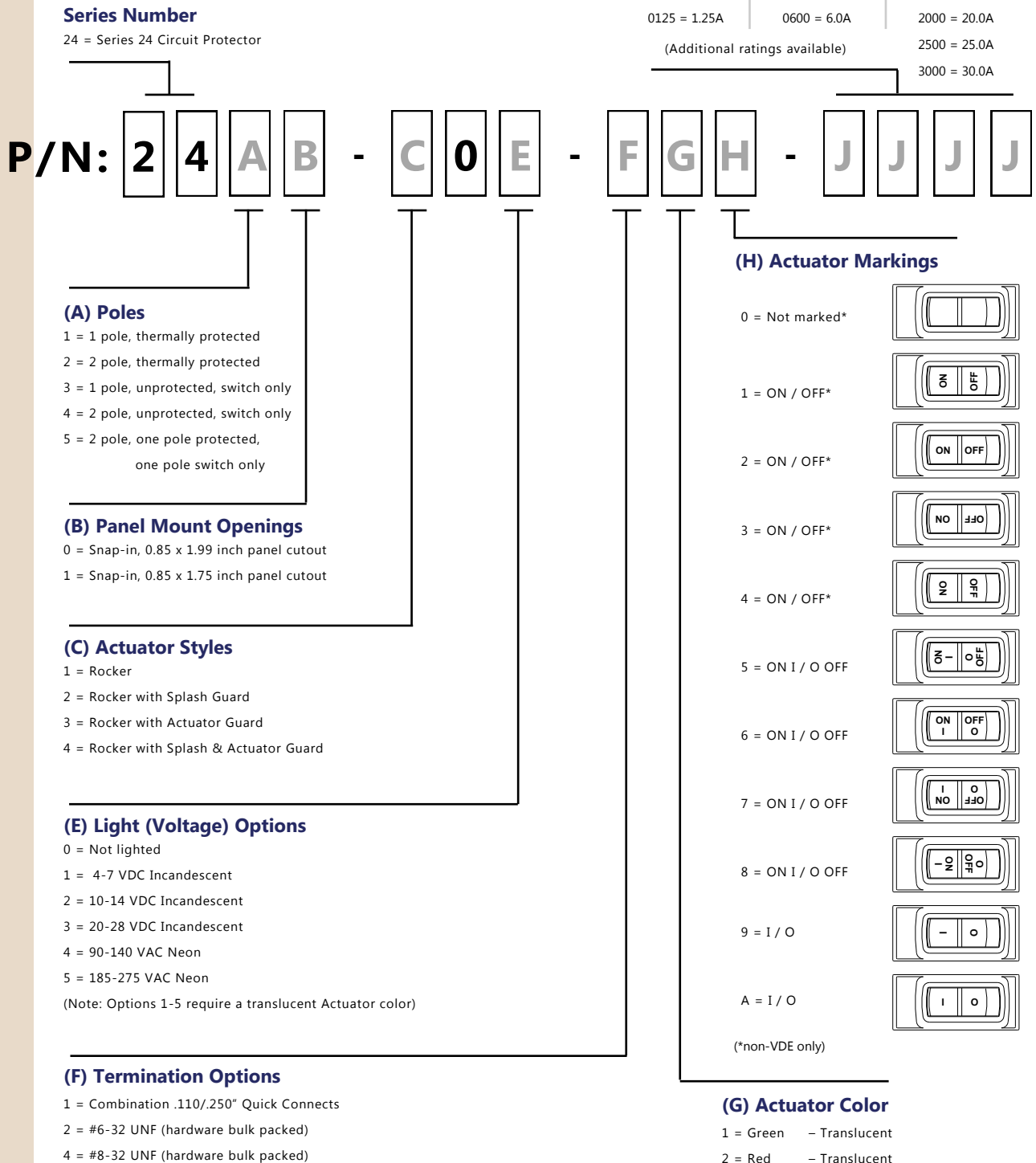

⚠ WARNING: Cancer & Reproductive Harm - www.P65Warnings.Ca.Gov/

• For More Information visit www.mechprod.com/MP_Prop_65



Mechanical Products Company

1112 N. Garfield St. Lombard, IL 60148 helpme@mechprod.com phone 630 | 953 | 4100 fax 630 | 953 | 4110 www.mechprod.com